

# Wagner Cone Prosthesis® Hip Stem

Ordering Information

## Implants

Wagner Cone Prosthesis  
125° Hip Stem



Wagner Cone Prosthesis  
135° Hip Stem



Protasul®-64 Alloy  
Taper 12/14  
Uncemented

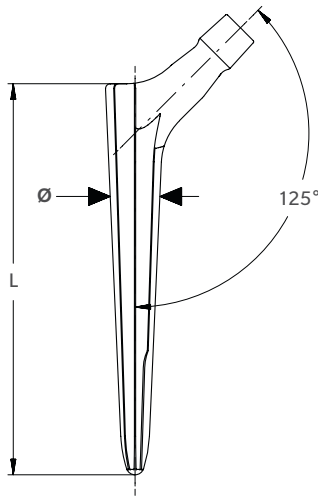

Protasul-64 Alloy  
Taper 12/14  
Uncemented

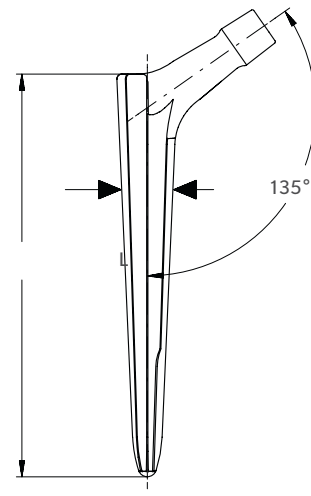

**STERILE R**

Diameter (mm)	Length (mm)	Size	Part Number
13	115.0	27.5	01.00561.213
14	125.5	31.7	01.00561.214
15	125.7	32.5	01.00561.215
16	125.9	33.4	01.00561.216
17	126.2	34.2	01.00561.217
18	126.4	35	01.00561.218
19	126.6	35.9	01.00561.219
20	126.8	36.7	01.00561.220
21	127.0	37.5	01.00561.221
22	127.2	38.3	01.00561.222
23	127.4	39.2	01.00561.223
24	127.6	40	01.00561.224





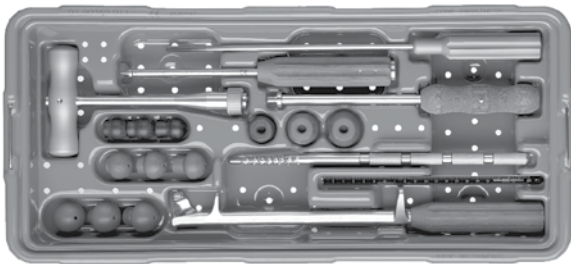

**STERILE R**

Diameter (mm)	Length (mm)	Size	Part Number
13	115.0	26.2	01.00561.313
14	125.5	29.7	01.00561.314
15	125.7	30.4	01.00561.315
16	125.9	31.1	01.00561.316
17	126.2	31.8	01.00561.317
18	126.4	32.5	01.00561.318
19	126.6	33.2	01.00561.319
20	126.8	33.9	01.00561.320
21	127.0	34.7	01.00561.321
22	127.2	35.4	01.00561.322
23	127.4	36.1	01.00561.323
24	127.6	36.8	01.00561.324





## Instruments



Description	Part Number
Tray for Wagner Cone Prosthesis Instruments (complete)	ZS01.00369.010
Tray Base for Wagner Cone Prosthesis Instruments (empty)	01.00369.011
Tray insert for Wagner Cone Prosthesis Instruments (empty)	01.00369.012
Standard Tray Cover, grey	01.00029.031

Product	Description	Diameter (mm)	Part Number
	Handle with Quick Coupling	–	75.00.25
	Gauge for the Medullary Cavity	–	75.11.40-01
	Extractor for Wagner Cone Prosthesis Stem	–	75.11.00-09
	Reamer	13 14 15 16 17 18 19 20 21 22 23 24	75.11.15-130 75.11.15-140 75.11.15-150 75.11.15-160 75.11.15-170 75.11.15-180 75.11.15-190 75.11.15-200 75.11.15-210 75.11.15-220 75.11.15-230 75.11.15-240
	Impactor	–	75.11.15-01
	Reduction Lever	–	75.01.38









## Instruments

Product	Description	Size & Taper (mm)	Part Number
	Repositioning Tops	28 32 36	78.00.38-28 78.00.38-32 78.00.38-36*
	Trial Heads	22 12/14 S 22 12/14 M 22 12/14 L	01.01519.225*, ** 01.01519.226*, ** 01.01519.227*, **
	Trial Heads	28 12/14 S 28 12/14 M 28 12/14 L 28 12/14 XL 32 12/14 S 32 12/14 M 32 12/14 L 32 12/14 XL 36 12/14 S 36 12/14 M 36 12/14 L 36 12/14 XL	01.01559.128 01.01559.228 01.01559.328 01.01559.428 01.01559.132 01.01559.232 01.01559.332 01.01559.432 01.01559.136* 01.01559.236* 01.01559.336* 01.01559.436*
	Ruler 20 cm	-	95.00.03
	AO Adaptor/TPP Adaptor	-	5637*
	Tray Trial Stems (complete)	-	ZS01.00568.100
	Tray Base Trial Stems (empty)	-	01.00568.100
	Tray Insert Trial Stems (empty)	-	01.00568.101
	Standard Tray Cover grey	-	01.00029.031

\*optional instrument, upon request

\*\*not available in the US

## Instruments

Product	Description	Size & Taper (mm)	Part Number		
	Trial Stem Proximal Part 125°	13	01.00569.213		
		14	01.00569.214		
		15	01.00569.215		
		16	01.00569.216		
		17	01.00569.217		
		18	01.00569.218		
		19	01.00569.219		
		20	01.00569.220		
		21	01.00569.221		
		22	01.00569.222		
		23	01.00569.223		
		24	01.00569.224		
			Trial Stem Proximal Part 135°	13	01.00569.313
				14	01.00569.314
				15	01.00569.315
				16	01.00569.316
				17	01.00569.317
				18	01.00569.318
				19	01.00569.319
				20	01.00569.320
				21	01.00569.321
				22	01.00569.322
				23	01.00569.323
				24	01.00569.324
	Trial Stem Distal Part			13	01.00569.113
				14	01.00569.114
				15	01.00569.115
				16	01.00569.116
				17	01.00569.117
				18	01.00569.118
				19	01.00569.119
				20	01.00569.120
				21	01.00569.121
				22	01.00569.122
				23	01.00569.123
				24	01.00569.124
			Screw for trial stems (4 units in the tray)	-	01.00569.001
			Impactor/Extractor for distal trial stem	-	01.00569.010
			Extractor for proximal trial stem	-	01.00569.011
			Impactor/Extractor	-	75.00.36
			Extractor	-	75.85.75
			Screwdriver	-	109.02.030
			X-ray Templates - (Wagner Cone)	135° / 115%	06.01368.000
				125° / 115%	06.01367.000



All content herein is protected by copyright, trademarks and other intellectual property rights, as applicable, owned by or licensed to Zimmer Biomet or its affiliates unless otherwise indicated, and must not be redistributed, duplicated or disclosed, in whole or in part, without the express written consent of Zimmer Biomet.

This material is intended for health care professionals. Distribution to any other recipient is prohibited.

For indications, contraindications, warnings, precautions, potential adverse effects and patient counselling information, see the package insert or contact your local representative; visit [www.zimmerbiomet.com](http://www.zimmerbiomet.com) for additional product information.

Not for distribution in France. Check for country product clearances and reference product specific instructions for use.

For Surgical Technique, please refer to 2647.X-GLBL-en Wagner Cone Prosthesis Stem Surg Tech.

[www.zimmerbiomet.com](http://www.zimmerbiomet.com)

©2020 Zimmer Biomet



**ZIMMER BIOMET**  
Your progress. Our promise.®

0623.1-GLBL-en-REV0420-A4



**Legal Manufacturer**  
Zimmer GmbH  
Sulzerallee 8  
8404 Winterthur, Switzerland  
Telephone +41/ (0)52 262 60 70  
Fax +41/ (0)52 262 01 39

[www.zimmerbiomet.com](http://www.zimmerbiomet.com)



CE mark on a surgical technique is not valid unless there is a CE mark on the product label.